

The walking area around the swimspa is for illustration purposes only.

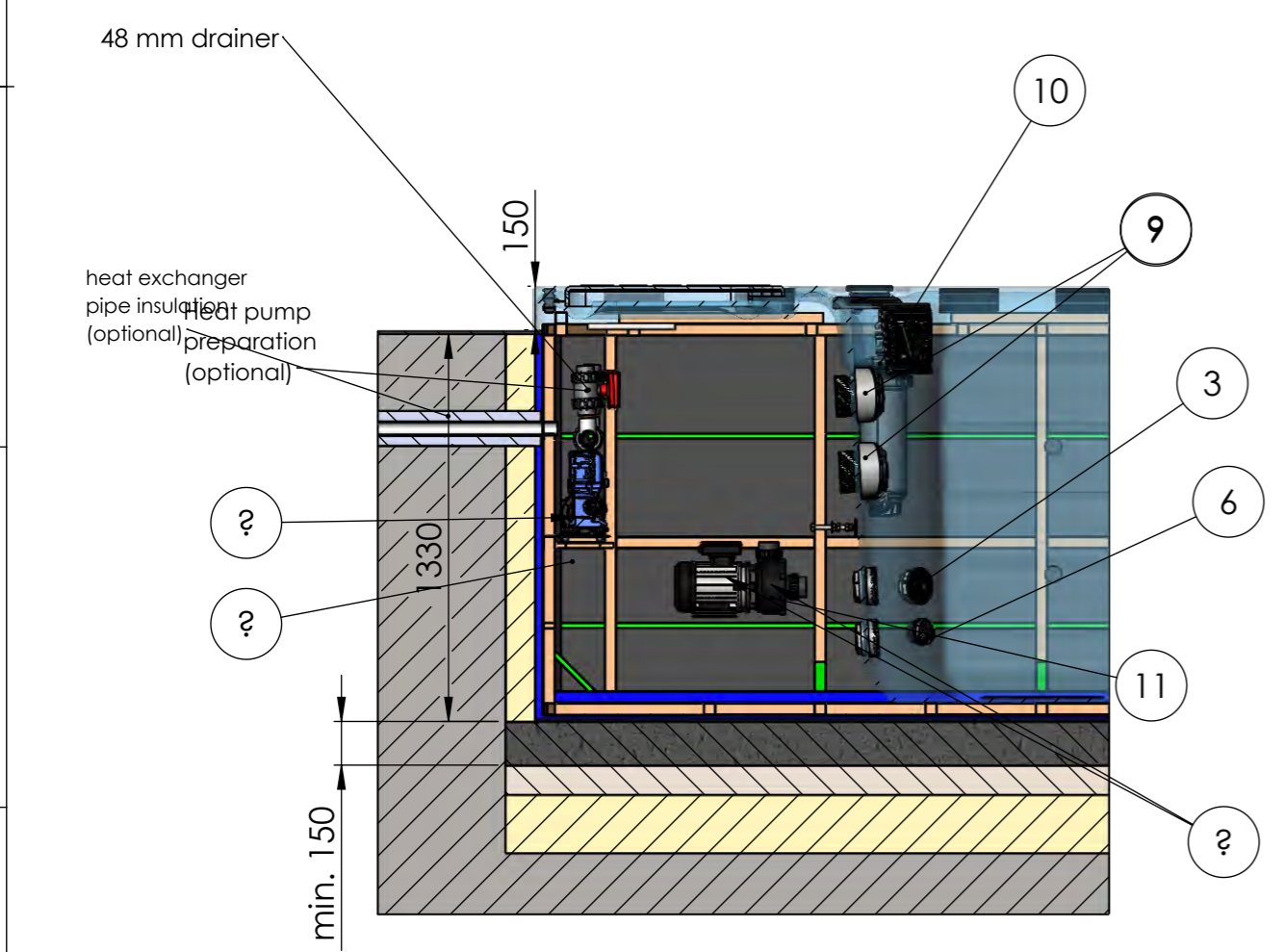

SECTION L-L

NO	Number	IFS - EN	Db
1	ACM0860	Control Panel - IN.K1001	1
2	AKU1830	Filter house for floating 50 sqf filters	2
3	ACM0531	Underwater Light - House RD	2
4	AJ00281	Sealing for self adjusting suction head nut Life	7
6	AJ00282	Circulation jet Medium gray 48 mm Life	2
9	AJ00347	Jet swim ovál W Riverjet	3
11	ACM0394	Spa Pump 3/0.6 HP - Two Speed	3
15	AKU1832	Filter House - Skimmer Cover round	2
16	AKU1842	Skimmer house with Wellis logo	2
17	ACM1052	Control box In.YE-5	1
22	ACM1092	UL ozone	1
23	ACM0901	Wifi receiver in.touch 2 Gecko EU&UK	1
24	bypass	Heat pump preparation (optional)	1
30	ABE0421	Suction head 2.5" Chrome (high)	7
31	AE00658	Silicone sealing for suction 2"	7
32	AKU3705	Swim Tether Pole Base	1
33			1
34	ABE1085		8
35	ABE0450		28
36	ABE0534	Iron pipe 21,3mm	4
37	ABE0562		1
38	ACM1366	Circulation pump WTC25M 750 W 1 Hp	1

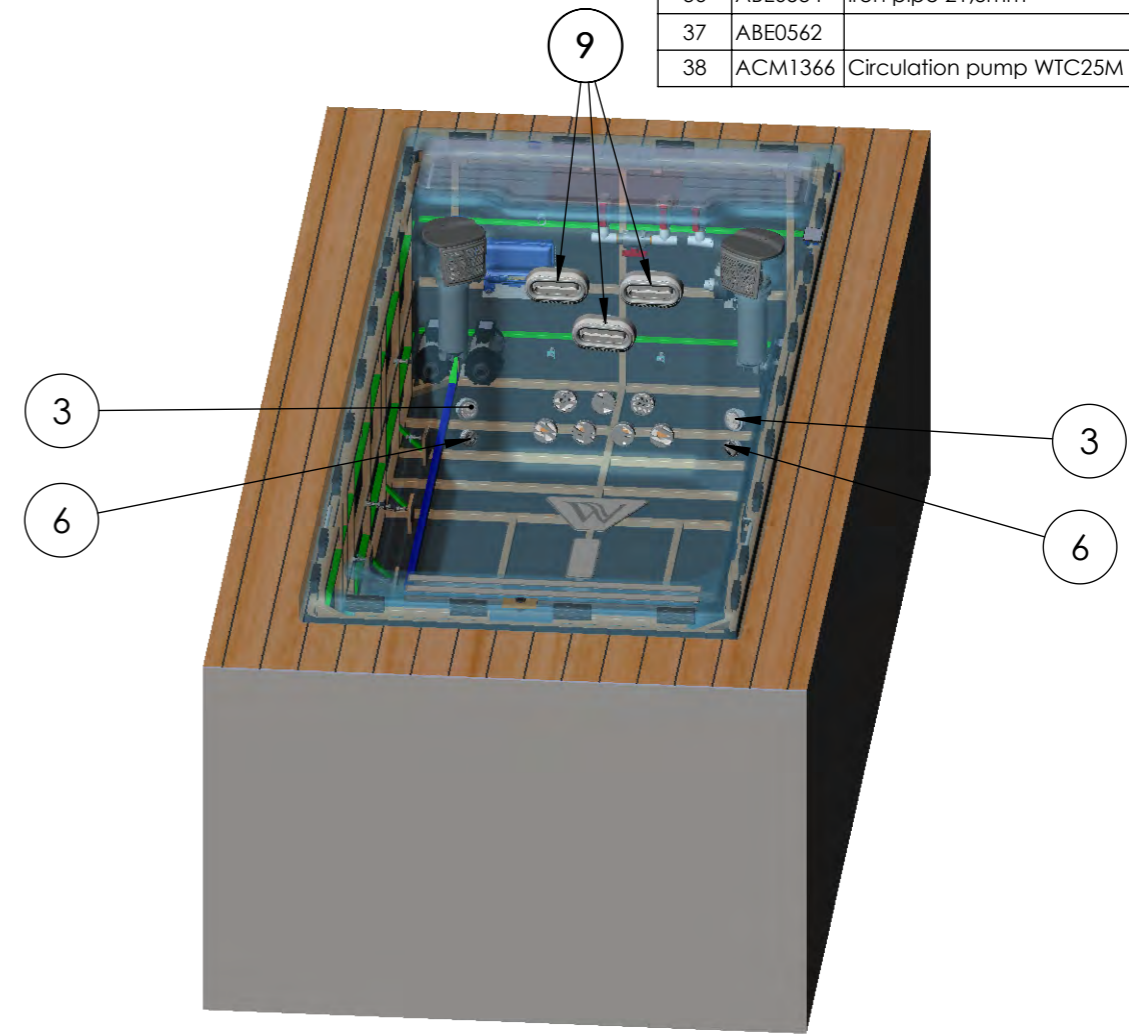

Termékcsalád: **Wellis\SwimLine**

Sheet name: Beach_Club_swim_EN		Projection		
File name: FJ_WU00054-Beach_Club				
Medence sz, h, m: 2350x6000x1470 mm		Elekt. ig. min.: 230 V - 32A - 50Hz / Elekt. ig. teljes: 400V - 3x16A - 50Hz		
1 személy ~75 kg	Medence súly: 1100 kg	Vezérlő: GECKO YE-5 + K1000		
Víziszorítás: 225 kg	Peremmagasság: 150 mm	Approved by: Bató Péter	Pr. No:	Number: WU00054
Minimum víz: 7200 liter	Created: 2026. 02. 25.	Drawer: bato.peter - 2026. 02. 25. 14:03:52	Fa. No:	F
		A3 M 1:25		page 5 / 8

INSTALLATION INSTRUCTIONS

Installation, connection and electrical installation can be done only by professionals!

The given dimensions are for information only, they may differ from reality due to the manufacturing technology of pools.

ATTENTION!

Pools can be installed only when electric shock protection compliance of the installed residual-current device is stated by the installation personnel in written form.



1. General installation instructions

A solid, level base (maximum 0.5% slope) is essential for setting up the pool. Make sure the cover or base is properly supporting the pool.

For this, you need to know the maximum load capacity of the cover. Consult a qualified architectural professional or structural engineer. To determine the weight, contents and parts of the pool, refer to the data table of the pool. This weight should not exceed the calculated static capacity per square meter, otherwise it may cause serious damage to the pool and the substrate. It is advisable to create a water confluence on the outlet side of the pool. Its purpose is to drain rainwater and splashing water from around the pool, and also to allow the water to flow away in case the pool is lowered at the bottom outlet.

a. Indoors/Basement

In case of placing the pool inside a building take into consideration the following requirements: The base must have a proper drain channel to prevent water collecting around the pool.

In case a new place is built for the pool, it is strongly recommended to install a floor drain to prevent damage due to water overflow or mechanical failure, etc.

If no floor drain is installed, our Company takes no responsibility for occurring damages.

Inside the room where the pool is installed, humidity can increase significantly. To prevent precipitating water and the occurrence of fungus, proper ventilation of the room is highly recommended.

It is also suggested to install a dehumidifier device in the room. Acryl absorbs heat from the sun rapidly, due to which the pool can suffer significant heat damage. In case the pool is installed between glass structures, please prevent the sunrays to reach the pool directly through the glass, otherwise temperatures can rise too high.

b. Outdoors/Closed terrace

If the pool is installed outdoors, it is recommended to build a horizontal, reinforced concrete base with min. 10-15 cm thickness. Do not expose the empty pool direct sunlight without proper protection (thermal cover on top). Please keep in mind that long term exposure to sunlight will damage the pool and its accessories.

c. Freestanding placement

If you do not want the recessed design, the product is equipped with a 5 mm ABS cover, which is optionally provided with Scandinavian insulation. The insulation is not UV stable and must be covered from the sun.

The cover cannot be attached to the pool, but can be wrapped around with any other external cover that covers the insulation.

2. Electrical installation

You must install a circuit breaker dedicated only for the pool, no other devices allowed to connect. You must also install a 30mA residual-current device (RCD).

Check your product type: WU00054 Beach Club swimspa

Check the minimal electric needs of your product: 230 V 32 A 50Hz

Check the optimal electric needs of your product: 400V 3x16 A 50HZ

Based on the information above, choose the appropriate cable size for your product.

For electric installation in case of cables not exceeding 10 meters in length, the appropriate cable cross section and length is given in the table on the right.

- For cable lengths exceeding 10 meters please consult a professional!

- In all cases, the electrical installation of the pool has to be done by an electrician.

- In case the optimal energy needs of the pool are met: the Spa pump and heating can work simultaneously.

- In case only the minimal energy needs of the pool are met: the Spa pump and heating can not work simultaneously.

- Installing the cables is recommended through the bottom cover (tray) by drilling a hole and using a cable gland. Recommended direction is shown on the drawing.

Min. cable length for installation is 3 m.

- The exact way of electrical installation is always unique, highly dependant on the location and environment of the pool.

Additional electrical installation (cable, circuit breaker and residual-current device) is the customer's responsibility.

These parts are not included in the pool packaging, need to be purchased separately.

Every pool has a dedicated installation drawing.

Make sure that the pool is connected to a 30 mA residual-current device.

Use copper wiring only.

If a fuse fails, replace it only with same type of fuse with same technical parameters.

The device must be connected to the house's Equipotential Bonding Grid.

We inform you that the functioning of Spa pumps listed in the bill of materials on the first page may differ from reality. For example, if 'ACM0394 Spa Pump 3/0.6 HP - Two Speed' pump is listed as two speed, but in reality it only works with one speed, that might be because for the best massage experience a bigger influx of water is needed, thus the pump will work with its highest speed.

Kábel keresztmetszet/ Cable profile		
1x16A	3x2,5mm ²	230 V
1x20A	3x4mm ²	230 V
1x25A	3x4mm ²	230 V
3x16A	5x4mm ²	400 V

Product family: **Wellis\SwimLine**

Sheet name: INFO_EN		Projection			
File name: FJ_WU00054-Beach_Club					
Dimension SPA: 2350x6000x1470 mm		Min.El. nds: 230 V - 32A - 50Hz / Opt.El. needs: 400V - 3x16A - 50Hz			
Weight of the SPA: 1100 kg		Rim height: 150 mm		Control box: GECKO YE-5 + K1000	
Water disp.: 225 kg		Approved by: Bató Péter		Pr. No:	Number: WU00054
Minimum water: 7200 liter		Created: 2026. 02. 25.		Fa. No:	F
		Drawer: bato.peter - 2026. 02. 25. 14:03:52		A3	M 1:15
				page 6 / 8	

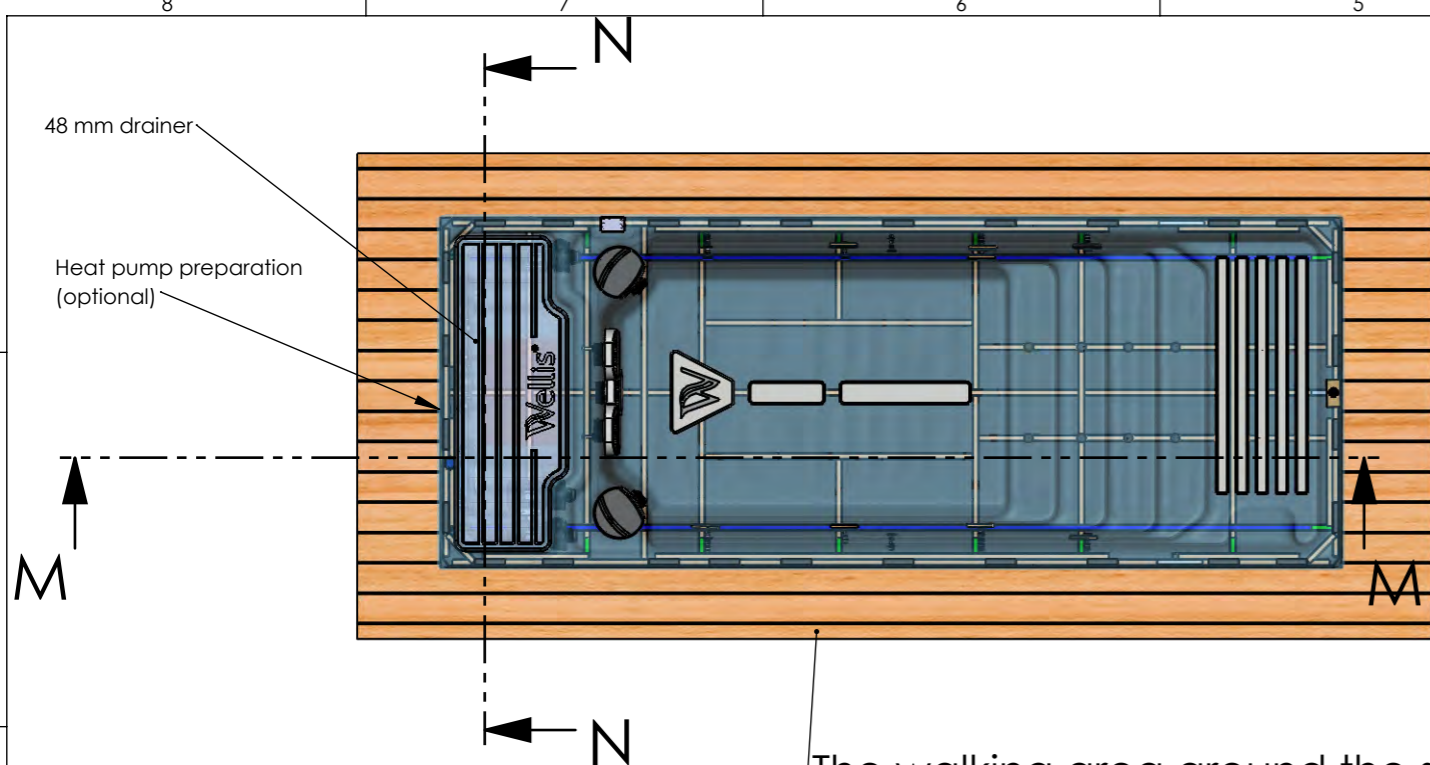

The walking area around the swimspa is for illustration purposes only.

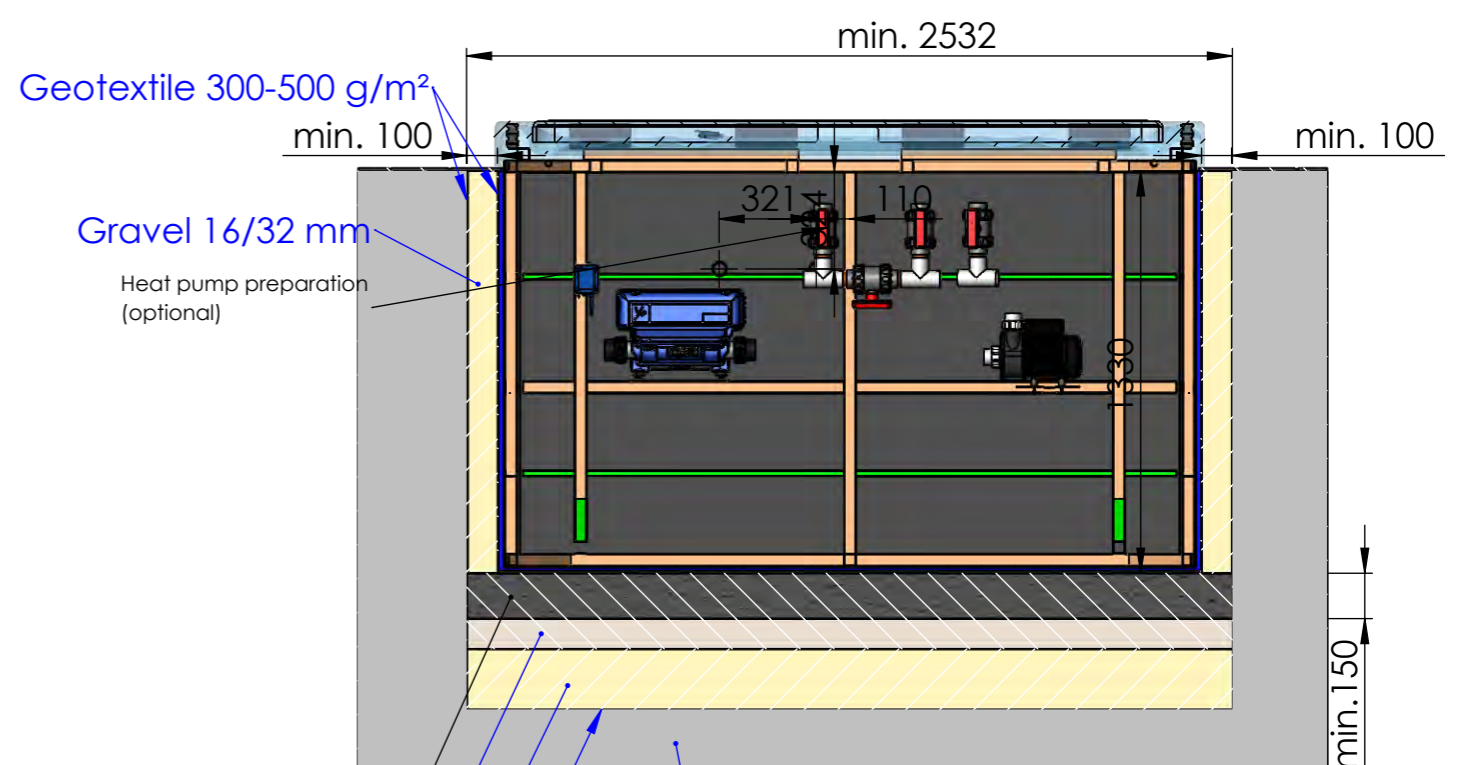

SECTION N-N
SCALE 1 : 25

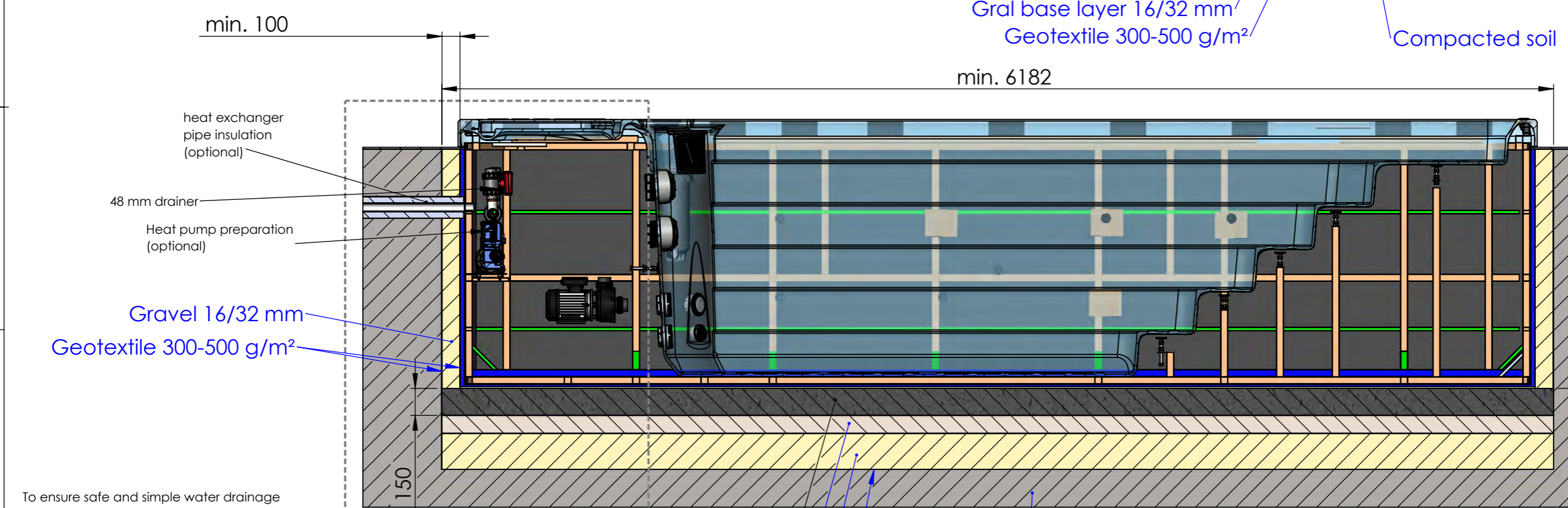

SECTION M-M
SCALE 1 : 25

To ensure safe and simple water drainage from the swimspa, it is recommended to install a fixed drain outlet near the technical area.
In case of poorly drained soil, care must be taken to drain excess water (e.g. by means of drainage)

This drawing is a possible general recommendation. The swimspa requires a foundation that is suitable for the prevailing soil conditions. Please consult your contractor.

Sheet name: CABINET_EN		Termékcsalád: Wellis\SwimLine	
File name: FJ_WU00054-Beach_Club		Projection	
Medence sz, h, m: 2350x6000x1470 mm		Elekt. ig. min.: 230 V - 32A - 50Hz / Elekt. ig. teljes: 400V - 3x16A - 50Hz	
Medence súly: 1100 kg	Vezérlő: GECKO YE-5 + K1000		Pr. No:
Peremmagasság: 150 mm	Approved by: Bató Péter	Fe. No:	Number: WU00054
Minimum víz: 7200 liter	Created: 2026. 02. 25.	Drawer: bato.peter - 2026. 02. 25. 14:03:52	F
		A3	M 1:17
		page 7 / 8	



Semicabinet swimspa installation guide with concrete base (general recommendation)

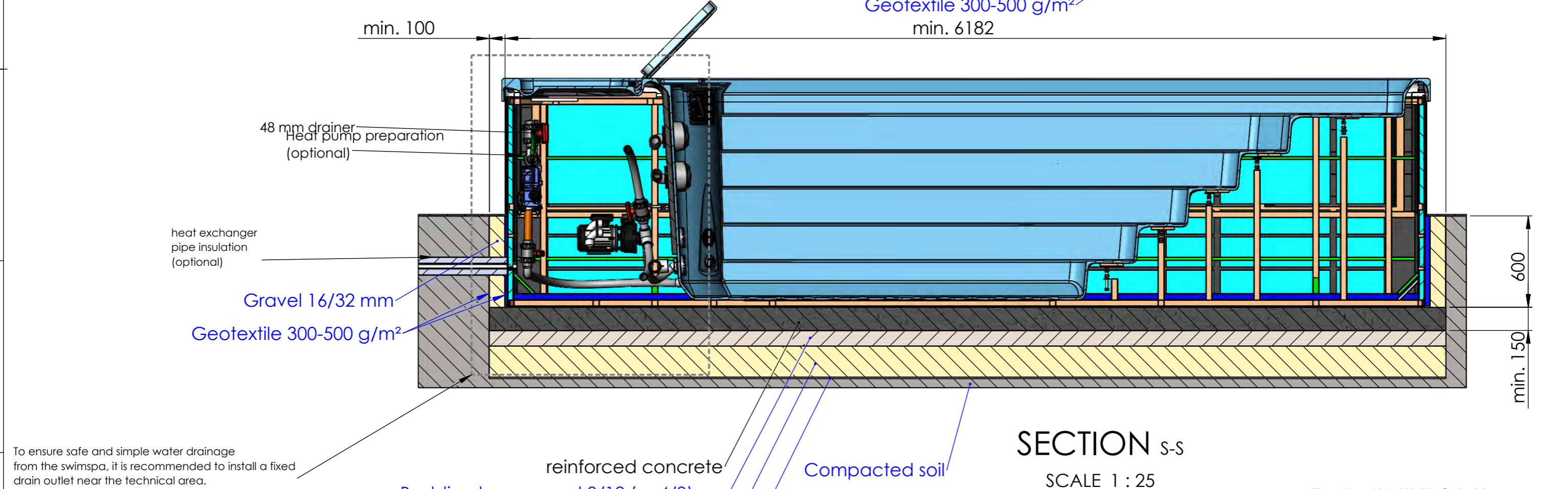
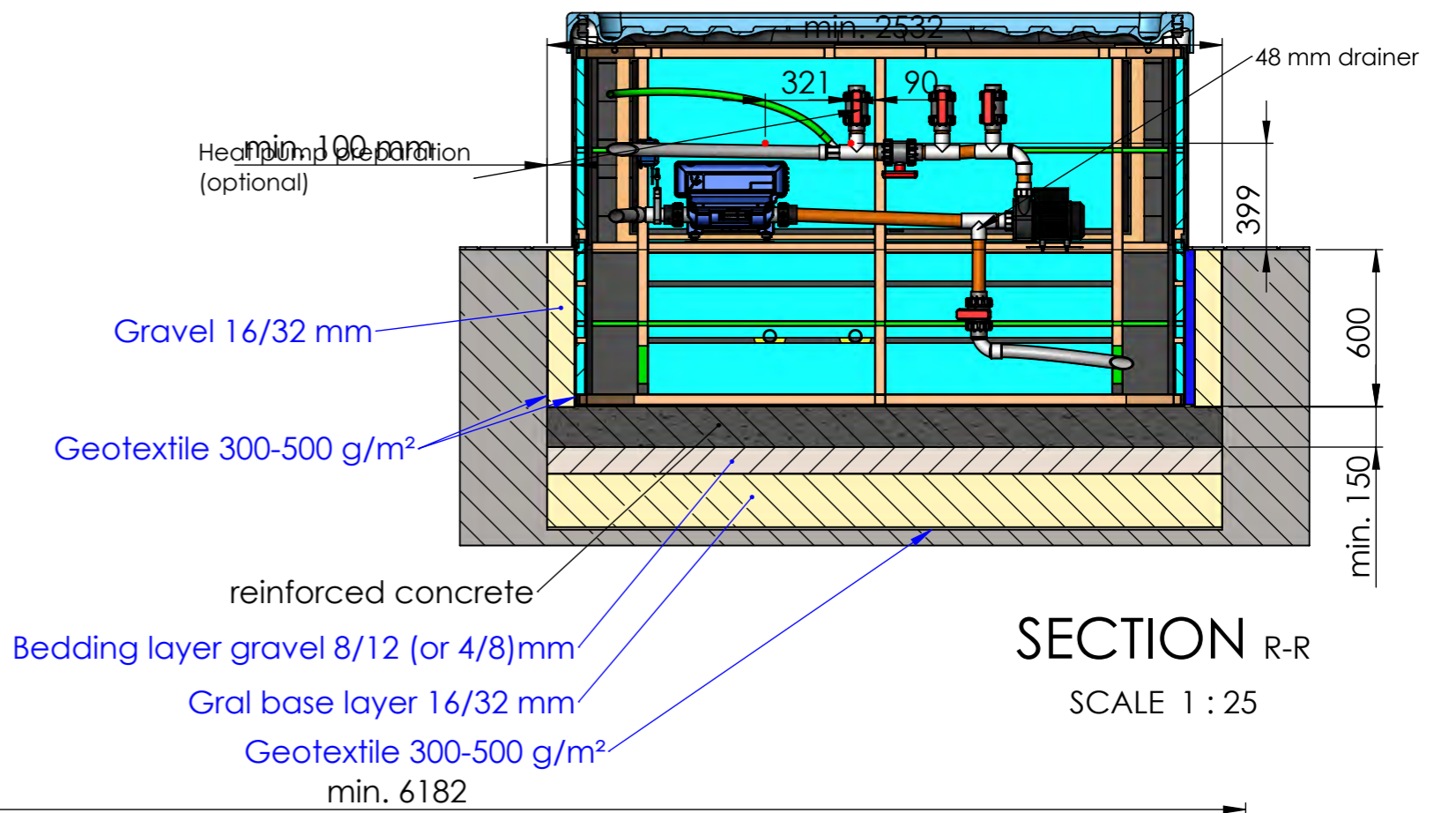
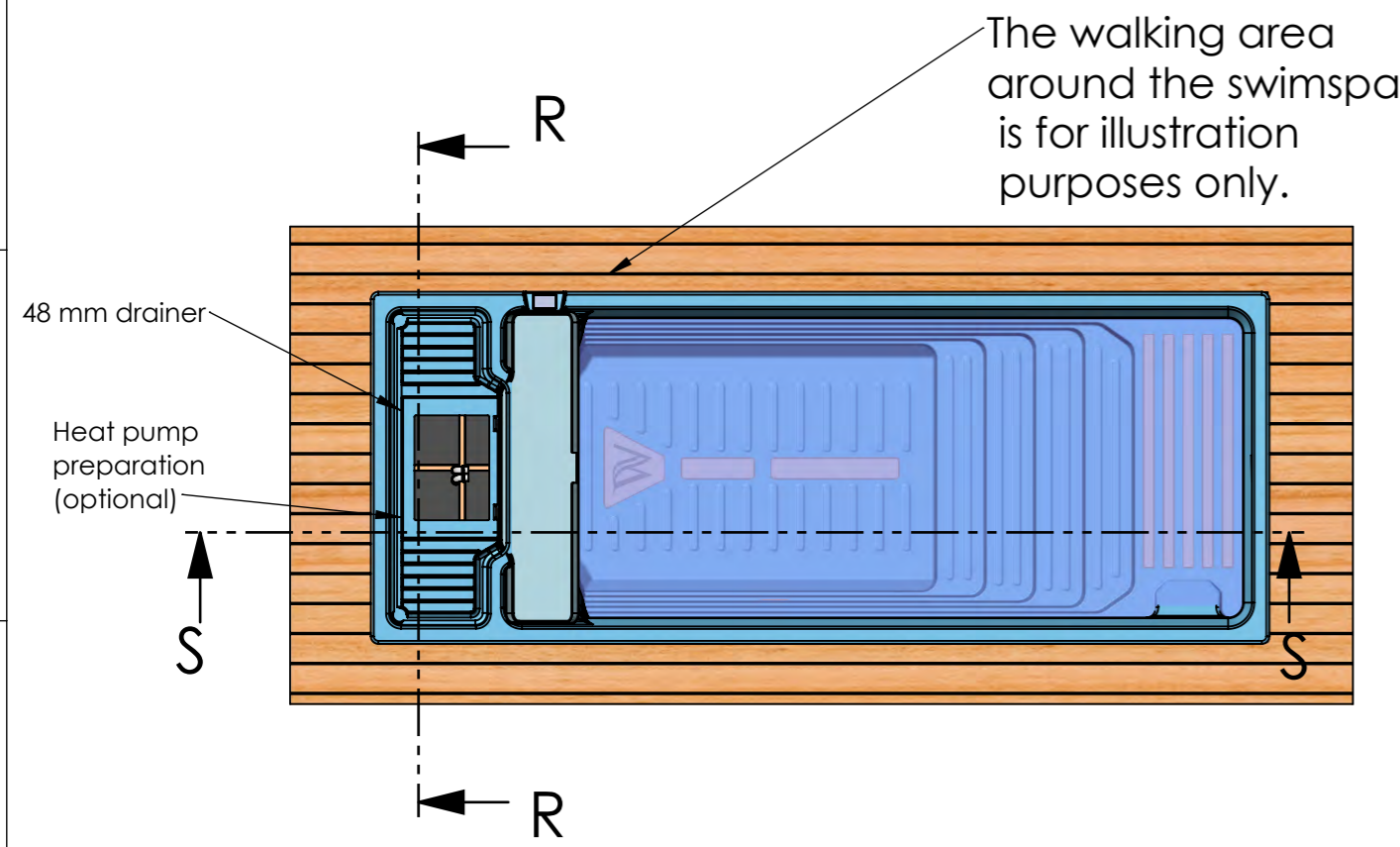

To ensure safe and simple water drainage from the swimspa, it is recommended to install a fixed drain outlet near the technical area.

In case of poorly drained soil, care must be taken to drain excess water (e.g. by means of drainage)

This drawing is a possible general recommendation. The swimspa requires a foundation that is suitable for the prevailing soil conditions. Please consult your contractor.

Sheet name: Semicabinet_EN		Termékcsalád: Wellis\SwimLine	
File name: FJ_WU00054-Beach_Club		Projection	
Medence sz, h, m: 2350x6000x1470 mm		Elekt. ig. min.: 230 V - 32A - 50Hz / Elekt. ig. teljes: 400V - 3x16A - 50Hz	
Medence súly: 1100 kg	Vezérlő: GECKO YE-5 + K1000		Pr. No:
Peremmagasság: 150 mm	Approved by: Bató Péter	Fe. No:	Number: WU00054
Minimum víz: 7200 liter	Created: 2026. 02. 25.	Drawer: bato.peter - 2026. 02. 25. 14:03:52	F
1 személy ~75 kg		A3 M 1:17	
Vízkielvezés: 225 kg		page 8 / 8	
Created: 2026. 02. 25.			